

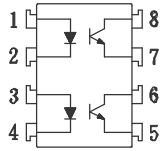

Schematic:



For dimensions and pin-outs, see the last page of this document.

Features:

1. Current transfer ratio
(CTR:MIN50% at $I_F=5mA$ $V_{ce}=5V$)
2. High isolation voltage between input and output
(Viso:5300Vrms).
3. Compact dual-in-line package.

Ordering:

Suffix to Standard Part Number

- V = VDE Compliant
- G = 10mm Lead Spread
- S = Surface Mount Lead-form
- T = Tape & Reel

Superior OPTO Part Number:

OPTO810

Absolute Maximum Ratings:

(Ta=25°C)

| | Parameter | Symbol | Rating | Unit |
|--------|---------------------------------|-----------|-------------|------|
| Input | Forward current | I_F | 50 | mA |
| | Peak forward current | I_{FM} | 1 | A |
| | Reverse voltage | V_R | 6 | V |
| | Power dissipation | P_d | 70 | mW |
| Output | Collector-emitter voltage | V_{CEO} | 55 | V |
| | Emitter-collector voltage | V_{ECO} | 6 | V |
| | Collector current | I_C | 50 | mA |
| | Collector power dissipation | P_C | 150 | mW |
| | Total power dissipation | P_{tot} | 200 | mW |
| | Isolation voltage 1 minute | Viso | 5300 | Vrms |
| | Operating temperature | T_{opr} | -55 to +100 | °C |
| | Storage temperature | T_{stg} | -55 to +125 | °C |
| | Soldering temperature 10 second | T_{sol} | 260 | °C |

Electrical Characteristics:

(Ta=25°C)

| | Parameter | Symbol | Conditions | MIN. | TYP. | MAX. | Unit |
|--------------------------|--------------------------------------|---------------|----------------------------------|--------------------|-----------|------|------|
| Input | Forward voltage | V_F | $I_F=20mA$ | — | 1.2 | 1.4 | V |
| | Peak forward voltage | V_{FM} | $I_{FM}=0.5A$ | — | — | 3.0 | V |
| | Reverse current | I_R | $V_R=4V$ | — | — | 10 | uA |
| | Terminal capacitance | C_t | $V=0, f=1kHz$ | — | 30 | — | pF |
| Output | Collector dark current | I_{CEO} | $V_{CE}=20V$ | — | — | 0.1 | uA |
| Transfer characteristics | Current transfer ratio | CTR | $I_F=5mA, V_{CE}=5V$ | 50 | — | — | % |
| | Collector-emitter saturation voltage | $V_{CE(sat)}$ | $I_F=5mA, I_C=1mA$ | — | — | 0.4 | V |
| | Isolation resistance | Riso | DC500V | 5×10^{10} | 10^{11} | — | ohm |
| | Floating capacitance | C_f | $V=0, f=1MHz$ | — | 0.6 | 1.0 | pF |
| | Cut-off frequency | f_c | $V_{CC}=5V, I_C=2mA, R_L=100ohm$ | — | 80 | — | kHz |
| | Response time (Rise) | | $V_{CE}=2V, I_C=2mA, R_L=100ohm$ | — | 4 | 18 | us |
| | Response time (Fall) | tf | | — | 3 | 18 | us |

Fig.1 Current Transfer Ratio vs. Forward Current

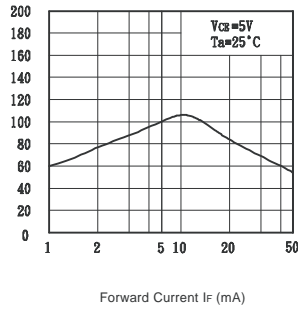

Fig.2 Collector Power Dissipation vs. Ambient Temperature

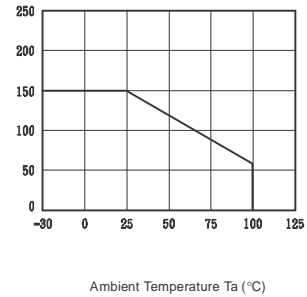

Fig.3 Collector Dark Current vs. Ambient Temperature

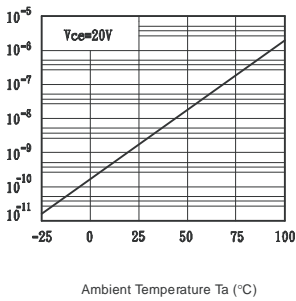

Fig.4 Forward Current vs. Ambient Temperature

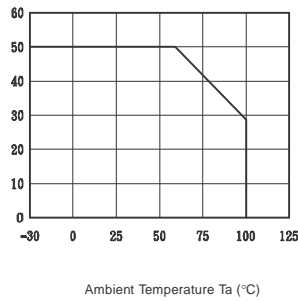

Fig.5 Forward Current vs. Forward Voltage

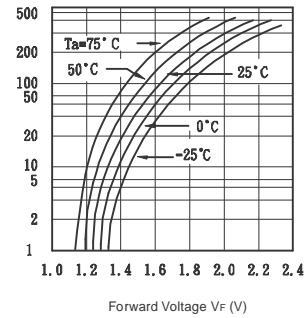

Fig.6 Collector Current vs. Collector-emitter Voltage

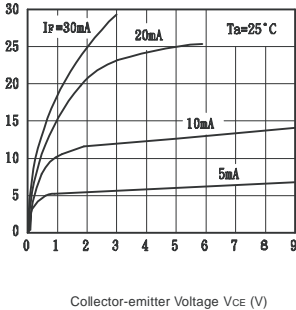

Fig.7 Relative Current Transfer Ratio vs. Ambient Temperature

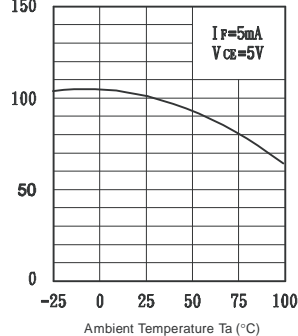

Fig.8 Collector-emitter Saturation Voltage vs. Ambient Temperature

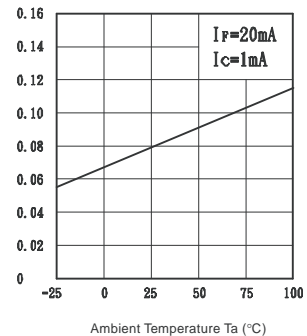

Fig.9 Collector-emitter Saturation Voltage vs. Forward Current

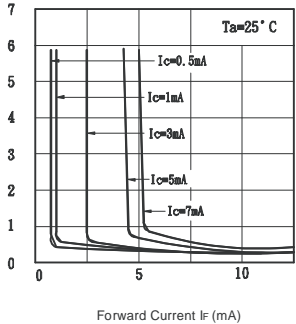

Fig.10 Response Time vs. Load Resistance

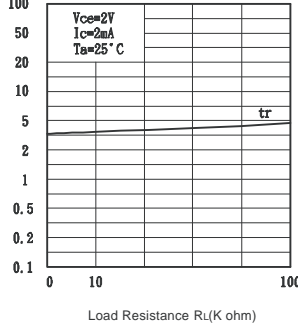

Fig.11 Response Time vs. Load Resistance

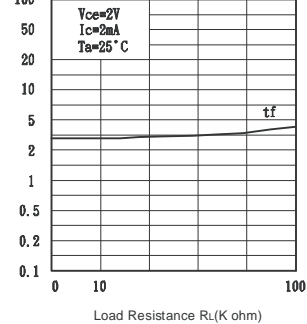

Fig.7 : 8-pin DIP type

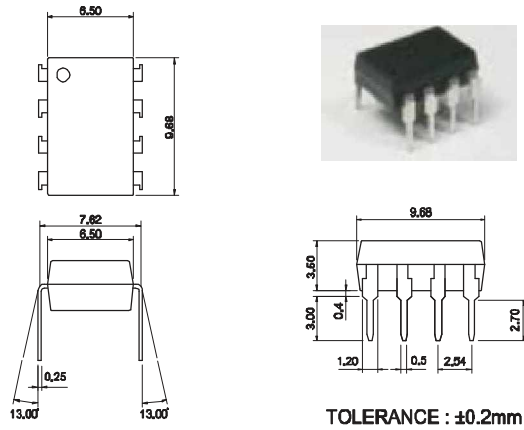

Fig.8 : 8-pin SMD type

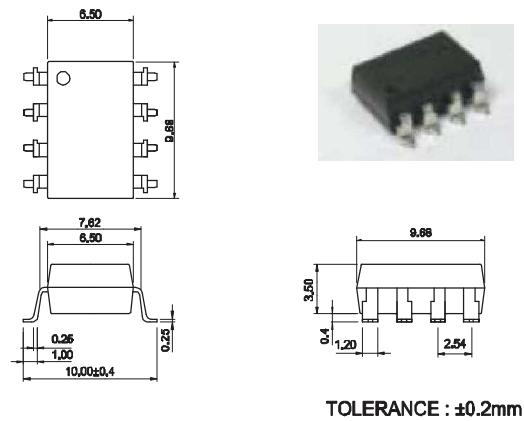

Fig.9 : 8-pin^G type

