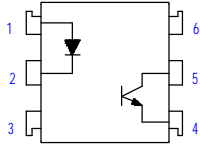

Schematic:

For dimensions and pin-outs, see the last page of this document.

Features:

1. Current transfer ratio
(CTR : min 50% at $I_F=10\text{mA}$ $V_{CE}=10\text{V}$)
2. High isolation voltage between input and output
(Viso : 5300Vrms, 7500vPK).
3. Compact dual-in-line package.

Ordering:

Suffix to Standard Part Number

- V = VDE Compliant
- G = 10mm Lead Spread
- S = Surface Mount Lead-form
- T = Tape & Reel

Superior OPTO Part Number:

OPTO610

Absolute Maximum Ratings:

	Parameter	Symbol	Rating	Unit
Input	Forward current	I_F	50	mA
	Peak forward current	I_{FM}	1	A
	Reverse voltage	V_R	6	V
	Power dissipation	P_D	70	mW
Output	Collector-emitter voltage	V_{CEO}	30	V
	Emitter-collector voltage	V_{ECO}	6	V
	Collector current	I_C	50	mA
	Collector power dissipation	P_C	150	mW
	Total power dissipation	P_{tot}	200	mW
	Isolation voltage 1 minute	V_{iso}	5300	Vrms
	Operating temperature	T_{opr}	-55 to +100	°C
	Storage temperature	T_{stg}	-55 to +125	°C
	Soldering temperature 10 second	T_{sol}	260	°C

Electrical Characteristics:

	Parameter	Symbol	Conditions	MIN.	TYP.	MAX.	Unit
Input	Forward voltage	V_F	$I_F=20\text{mA}$	–	1.2	1.4	V
	Peak forward voltage	V_{FM}	$I_{FM}=0.5\text{A}$	–	–	3.5	V
	Reverse current	I_R	$V_R=4\text{V}$	–	–	10	uA
	Terminal capacitance	C_t	$V=0, f=1\text{kHz}$	–	30	–	pF
Output	Collector dark current	I_{CEO}	$V_{CE}=20\text{V}$	–	–	0.1	Ua
Transfer characteristics	Current transfer ratio	CTR	$I_F=10\text{mA}, V_{CE}=10\text{V}$	50	–	–	%
	Collector-emitter saturation voltage	$V_{CE(sat)}$	$I_F=10\text{mA}, I_C=0.5\text{mA}$	–	–	0.4	V
	Isolation resistance	Riso	DC500V	5×10^{10}	10^{11}	–	ohm
	Floating capacitance	C_f	$V=0, f=1\text{MHz}$	–	0.6	1.0	pF
	Cut-off frequency	f_c	$V_{CC}=5\text{V}, I_C=2\text{mA}, R_L=100\text{ohm}$	–	80	–	kHz
	Response time (Rise)	t_r	$V_{ce}=2\text{V}, I_C=2\text{mA}, R_L=100\text{ohm}$	–	5	20	us
	Response time (Fall)	t_f		–	4	20	us

Fig. 1 Current Transfer Ratio Vs. Forward Current

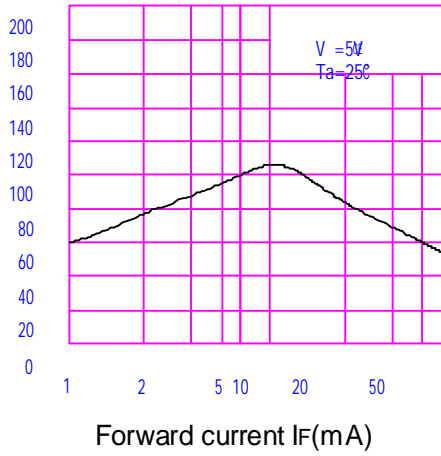

Fig.3 Collector Dark Current vs. Ambient Temperature

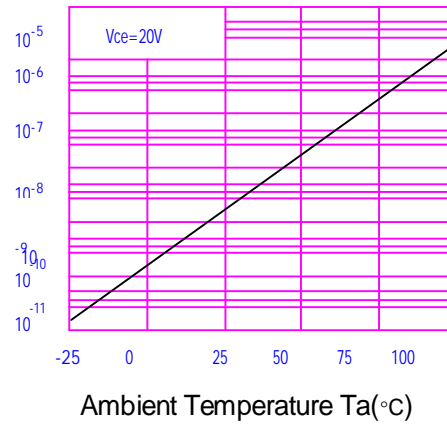
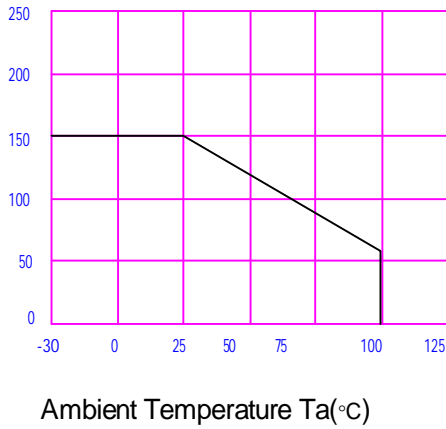

Fig.4 Forward Current vs. Ambient Temperature

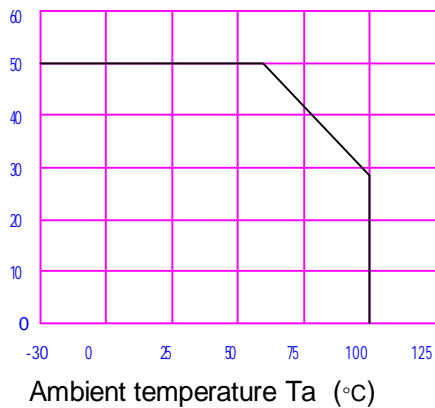

Fig.5 Forward Current vs. Forward Voltage

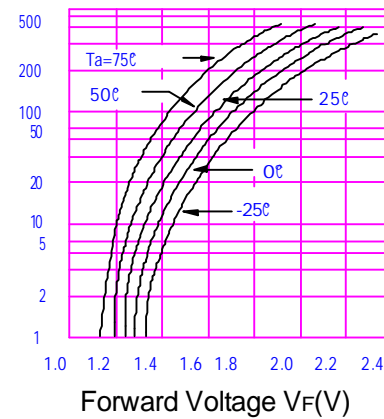
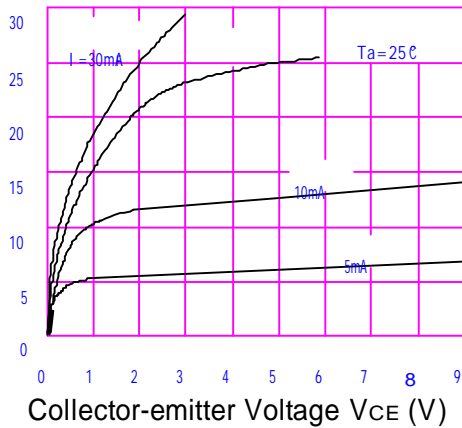

Fig.6 Collector Current vs. Collector-emitter Voltage

Fig.7 Relative Current Transfer Ratio vs. Ambient Temperature

Ambient temperature $T_a(^{\circ}C)$
Fig.6 Collector Current vs.
Collector-emitter Voltage



Forward Voltage $V_F(V)$
Fig.7 Relative Current Transfer Ratio
vs. Ambient Temperature

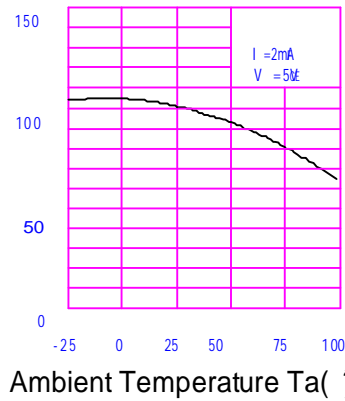

Fig.8 Collector-emitter Saturation
Voltage vs. Ambient Temperature

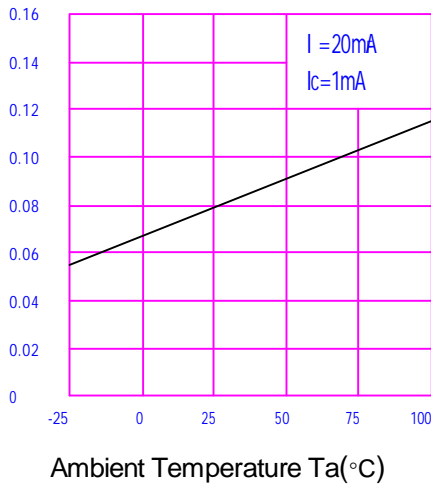

Fig.9 Collector-emitter Saturation
Voltage vs. Forward Current

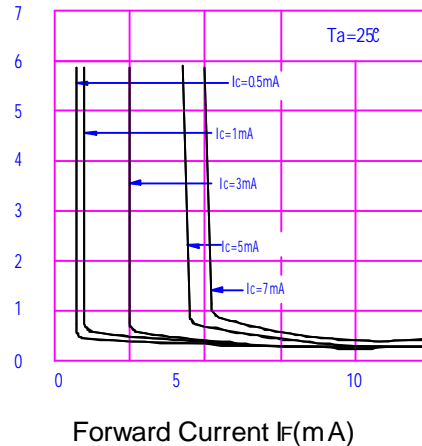

Fig.10 Response Time vs. Load
Resistance

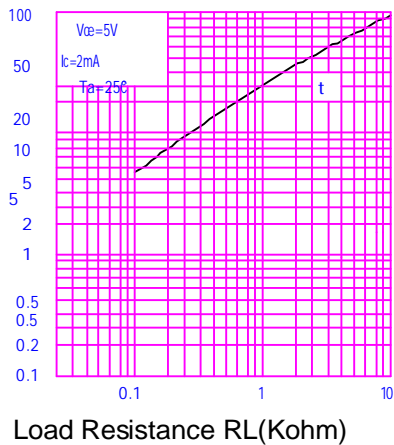

Fig.11 Response Time vs. Load
Resistance

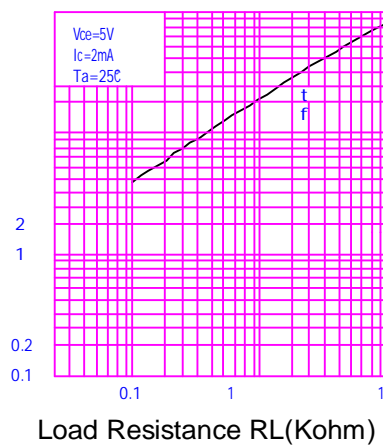

Fig.4 : 6-pin DIP type

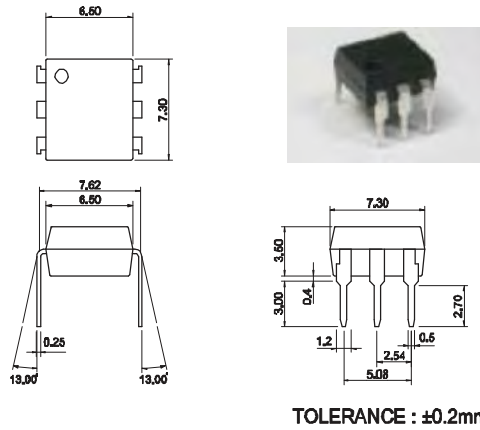

Fig.5 : 6-pin SMD type

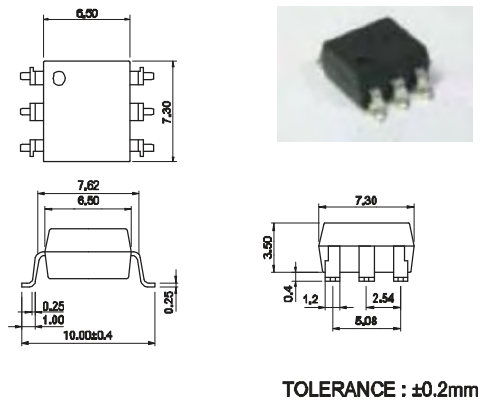
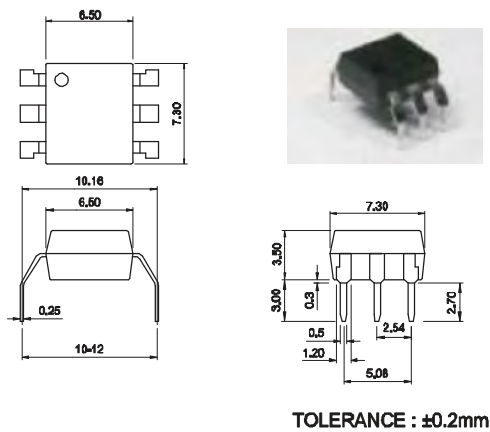

Fig.6 : 6-pin G type



6-pin SMD Carrier Tape & Reel

Unit:mm

Tape

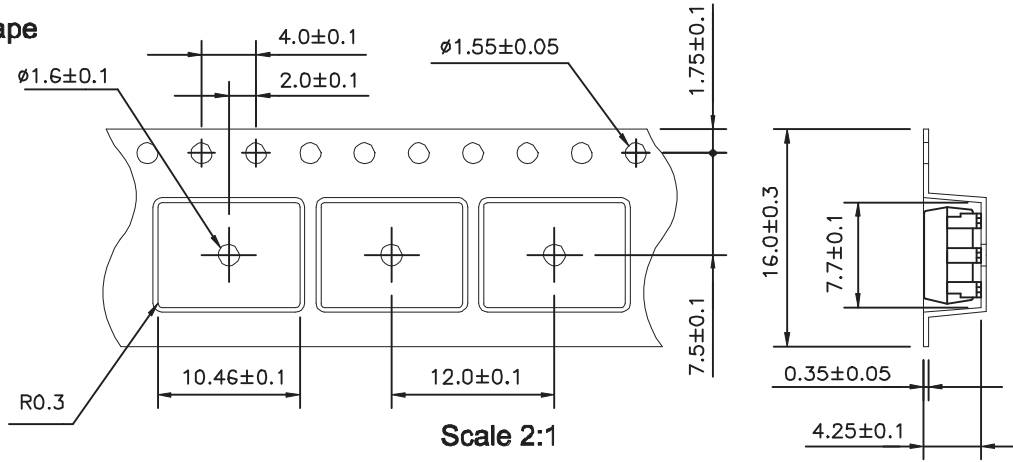

Scale 2:1

Material : PS

Direction

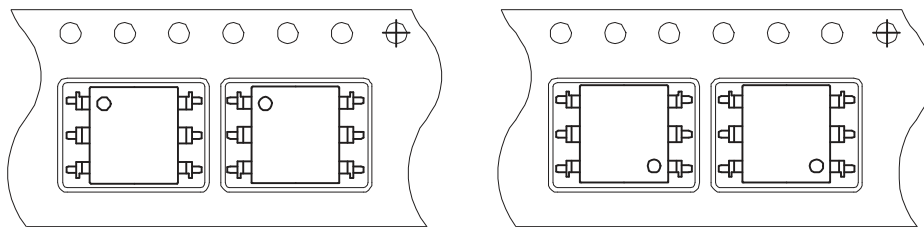

TL

TR

Reel

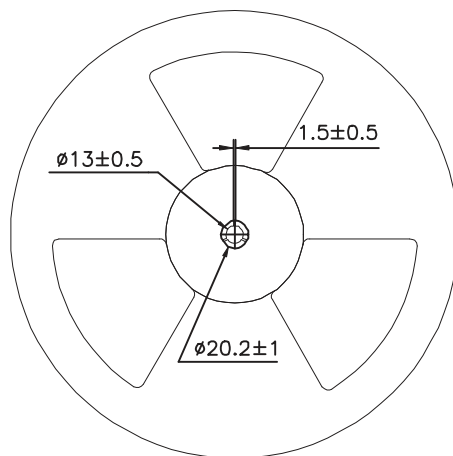

Scale 1:5

Material : PVC



Packing:1000pcs/reel