

Schematic:

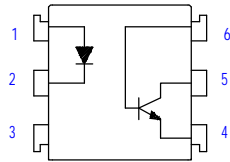

For dimensions and pin-outs, see the last page of this document.

Features:

1. Current transfer ratio
(CTR 100-500% at $I_F=10mA$ $V_{ce}=10V$)
2. High isolation voltage between input and output
(Viso = 5300Vrms, 7500Vpk).

Ordering:

Suffix to Standard Part Number

- V = VDE Compliant
- G = 10mm Lead Spread
- S = Surface Mount Lead-form
- T = Tape & Reel

Superior OPTO Part Number:

OPTO611

Absolute Maximum Ratings:

Parameter		Symbol	Rating	Unit
Input	Peak forward current	I_{FM}	1	A
	Reverse voltage	V_R	6	V
	Power dissipation	P_D	70	mW
	Collector-emitter voltage	V_{CEO}	70	V
Output	Emitter-collector voltage	V_{ECO}	6	V
	Collector-base voltage	V_{CBO}	60	V
	Emitter-base voltage	V_{EBO}	6	V
	Collector current	I_C	50	mA
	Collector power dissipation	P_C	150	mW
	Total power dissipation	P_{tot}	200	mW
	Isolation voltage 1 minute	V_{iso}	5300	Vrms
	V_{iso}	7500	Vpk	
Operating temperature		T_{opr}	-55 to +100	°C
Storage temperature		T_{stg}	-55 to +125	°C
Soldering Temperature 10 seconds		T_{sol}	260	°C

Electrical Characteristics:

Parameter		Symbol	Conditions	MIN.	TYP.	MAX.	Unit
Input	Forward voltage	V_F	$I_F=20mA$	-	1.2	1.4	V
	Peak forward voltage	V_{FM}	$I_{FM}=0.5A$	-	-	3.5	V
	Reverse current	I_R	$V_R=4V$	-	-	10	uA
	Terminal capacitance	C_t	$V=0, f=1kHz$	-	30	-	pF
Output	Collector dark current	I_{CEO}	$V_{CE}=20V$	-	-	0.1	uA
Transfer characteristics	Current transfer ratio	CTR	$I_F=10mA, V_{CE}=10V$	100	-	500	%
	Collector-emitter saturation voltage	$V_{CE(sat)}$	$I_F=16mA, I_C=2mA$	-	-	0.4	V
	Isolation resistance	Riso	DC500V	5×10^{10}	10^{11}	-	ohm
	Floating capacitance	C_f	$V=0, f=1MHz$	-	0.6	1.0	Pf
	Cut-off frequency	f_c	$V_{cc}=5V, I_C=2mA, R_L=100ohm$	-	80	-	kHz
	Response time (Rise)	t_r	$V_{ce}=2V, I_C=2mA, R_L=100ohm$	-	5	20	us
Response time (Fall)	t_f		-	4	20	us	

Fig. 1 Current Transfer Ratio
 Vs. Forward Current

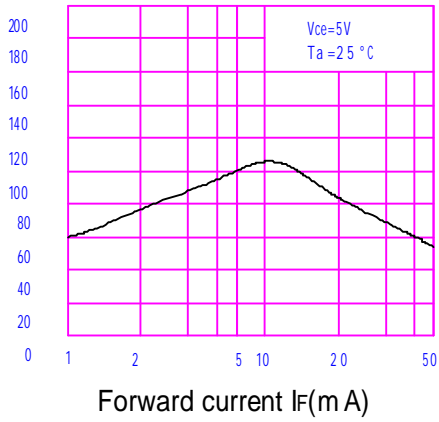

Fig.2 Collector Power Dissipation
 vs. Ambient Temperature

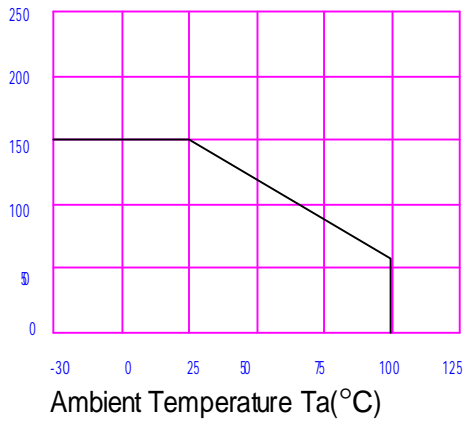

Fig.3 Collector Dark Current vs.
 Ambient Temperature

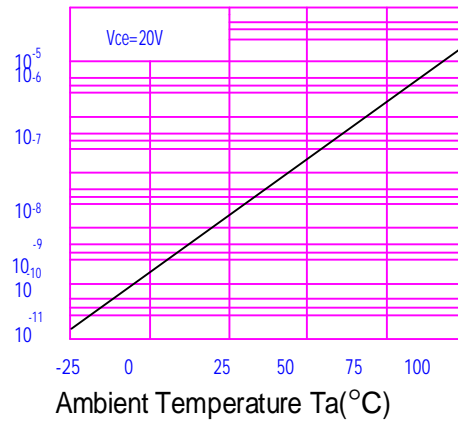

Fig.4 Forward Current vs.
 Ambient Temperature

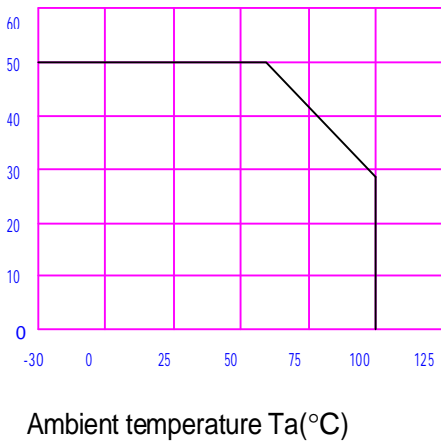

Fig.5 Forward Current vs.
 Forward Voltage

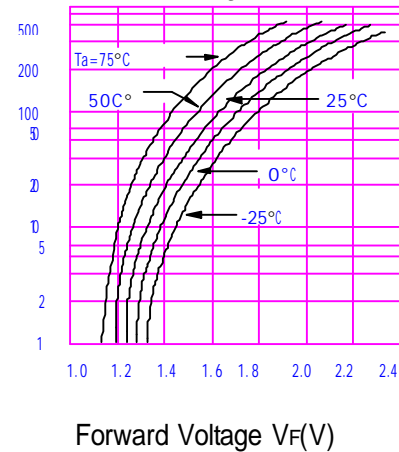
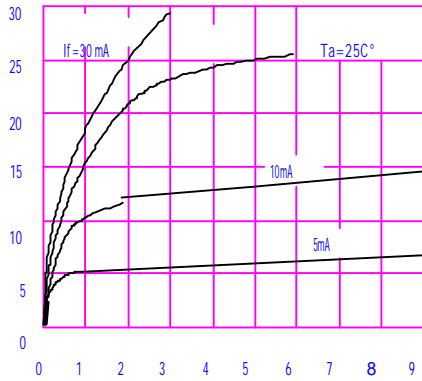

Fig.6 Collector Current vs.

Collector-emitter Voltage



Collector-emitter Voltage V_{CE} (V)

Fig.7 Relative Current Transfer Ratio

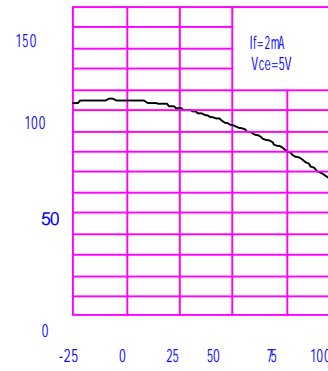

Ambient Temperature T_a (°C)

Fig.8 Collector-emitter Saturation Voltage vs. Ambient Temperature

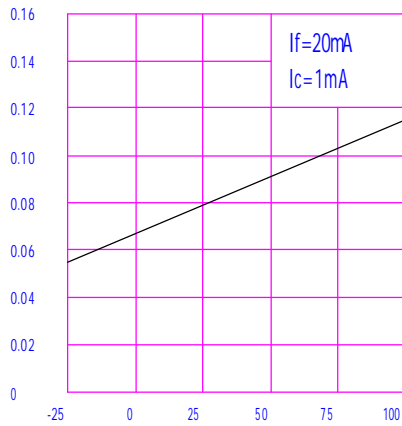

Ambient Temperature T_a (°C)

Fig.9 Collector-emitter Saturation Voltage vs. Forward Current

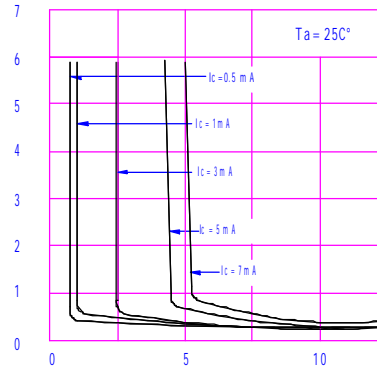

Forward Current I (mA)

Fig.10 Response Time vs. Load Resistance

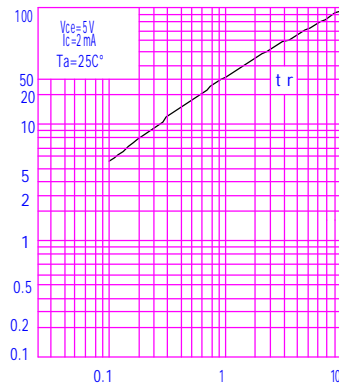

Load Resistance R_L (Kohm)

Fig.11 Response Time vs. Load Resistance

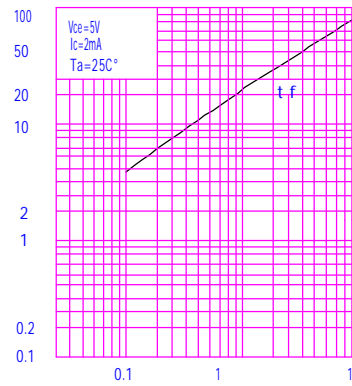

Load Resistance R_L (Kohm)

Fig.4 : 6-pin DIP type

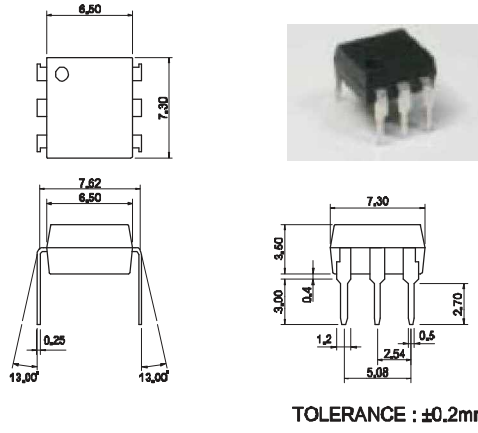

Fig.5 : 6-pin SMD type

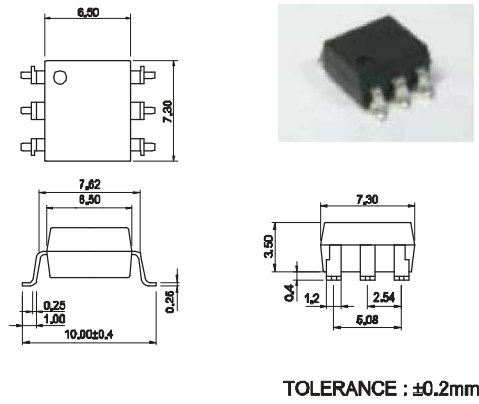
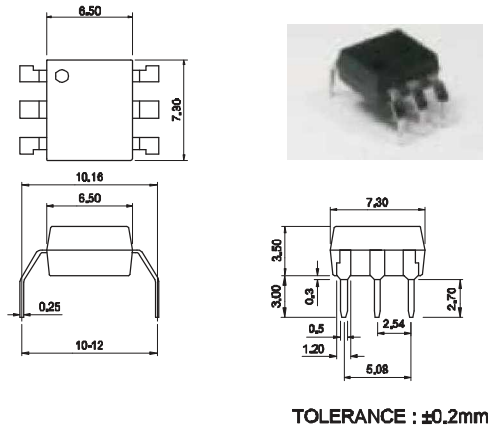

Fig.6 : 6-pin G type



6-pin SMD Carrier Tape & Reel

Unit:mm

Tape

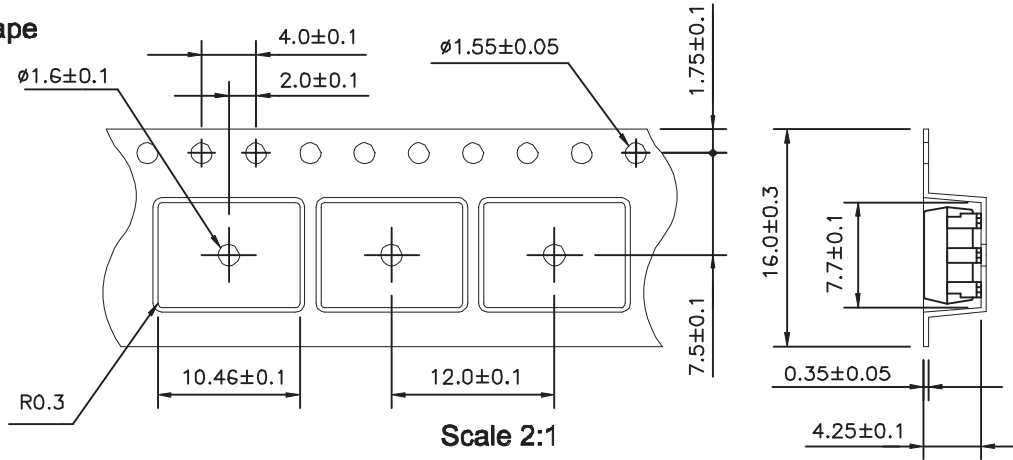

Scale 2:1

Material : PS

Direction

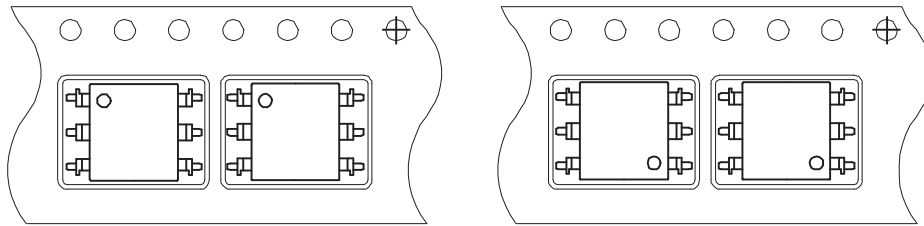

TL

TR

Reel

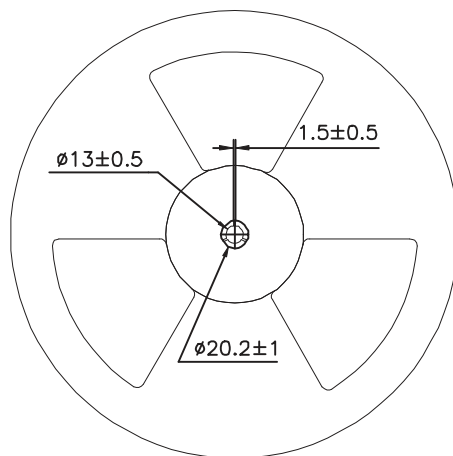

Scale 1:5

Material : PVC



Packing:1000pcs/reel