

Schematic:

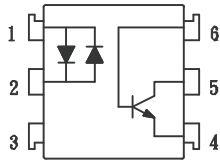

For dimensions and pin-outs, see the last page of this document.

Features:

1. Current transfer ratio
(CTR:MIN.100% at IF=10mA, Vce=10V)
- 2.. High isolation voltage between input and output (Viso:5300Vrms).
3. AC input.

Ordering:

Suffix to Standard Part Number

- V = VDE Compliant
- G = 10mm Lead Spread
- S = Surface Mount Lead-form
- T = Tape & Reel

Superior OPTO Part Number:

OPTO641

Absolute Maximum Ratings:

(Ta=25°C)

	Parameter	Symbol	Rating	Unit
Input	Forward current	IF	±50	mA
	Peak forward current	IFM	±1	A
	Power dissipation	PD	70	mW
Output	Collector-emitter voltage	VCEO	30	V
	Emitter-collector voltage	VECO	6	V
	Collector-base voltage	VCBO	30	V
	Emitter-base voltage	VEBO	6	V
	Collector current	IC	100	mA
	Collector power dissipation	PC	150	mW
	Total power dissipation	Ptot	200	mW
	Isolation voltage 1 minute	Viso	5300	Vrms
	Operating temperature	Topr	-55 to +100	°C
	Storage temperature	Tstg	-55 to +125	°C
	Soldering temperature 10 second	Tsol	260	°C

Electrical Characteristics:

(Ta=25°C)

	Parameter	Symbol	Conditions	MIN.	TYP.	MAX.	Unit
Input	Forward voltage	VF	IF =±20mA	—	1.2	1.4	V
	Peak forward voltage	VFM	IFM =±0.5A	—	—	3.5	V
	Terminal capacitance	Ct	V=0, f=1kHz	—	30	—	pF
Output	Collector dark current	ICEO	VCE =20V, IF =0	—	—	0.1	uA
Transfer characteristics	Current transfer ratio	CTR	IF =10mA, VCE =10V	100	—	—	%
	Collector-emitter saturation voltage	VCE (sat)	IF =10mA, IC =0.5mA	—	—	0.4	V
	Isolation resistance	Riso	DC500V	5X10 ¹⁰	10 ¹¹	—	ohm
	Floating capacitance	Cf	V=0, f=1MHz	—	0.6	1.0	pF
	Cut-off frequency	fc	VCC=5V, IC=2mA, RL=100ohm	—	80	—	kHz
	Response time (Rise)		VCE=2V, IC=2mA, RL=100ohm	—	5	20	us
	Response time (Fall)	tf		—	4	20	us

CTR Selections are available upon request

Fig.1 Current Transfer Ratio vs. Forward Current

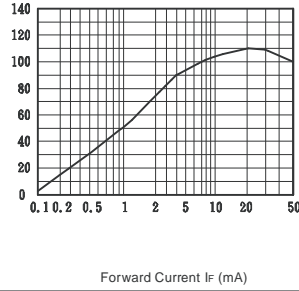

Fig.2 Collector Power Dissipation vs. Ambient Temperature

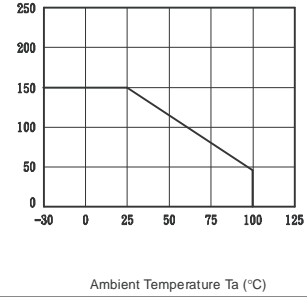

Fig.3 Collector Dark Current vs. Ambient Temperature

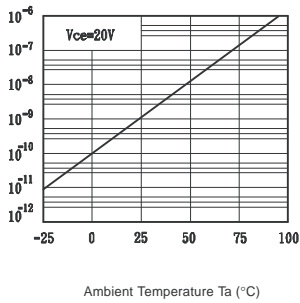

Fig.4 Forward Current vs. Ambient Temperature

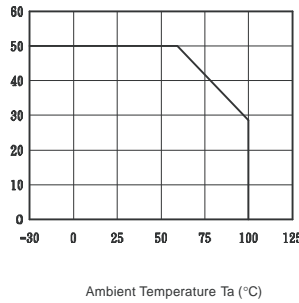

Fig.5 Forward Current vs. Forward Voltage

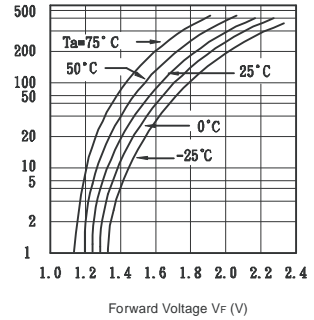

Fig.6 Collector Current vs. Collector-emitter Voltage

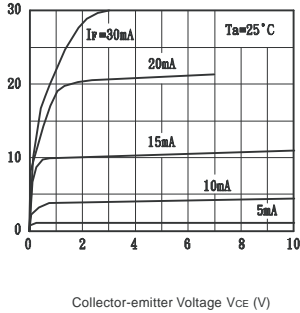

Fig.7 Relative Current Transfer Ratio vs. Ambient Temperature

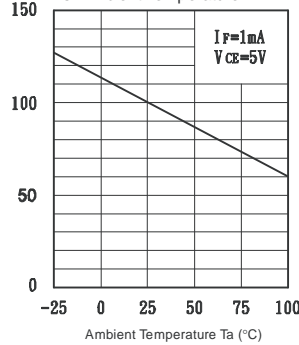

Fig.8 Collector-emitter Saturation Voltage vs. Ambient Temperature

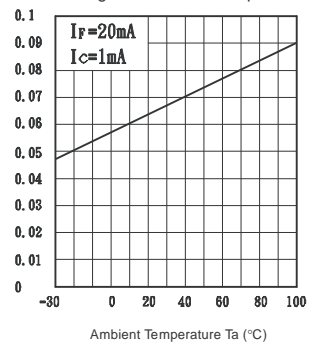

Fig.9 Collector-emitter Saturation Voltage vs. Forward Current

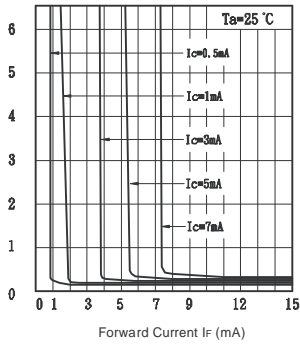

Fig.10 Response Time vs. Load Resistance

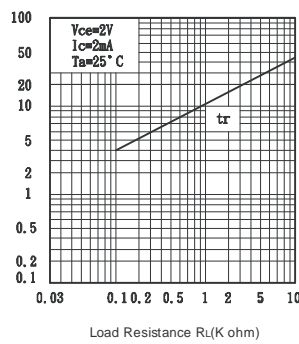

Fig.11 Response Time vs. Load Resistance

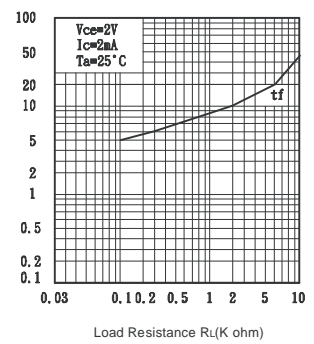

Fig.4 : 6-pin DIP type

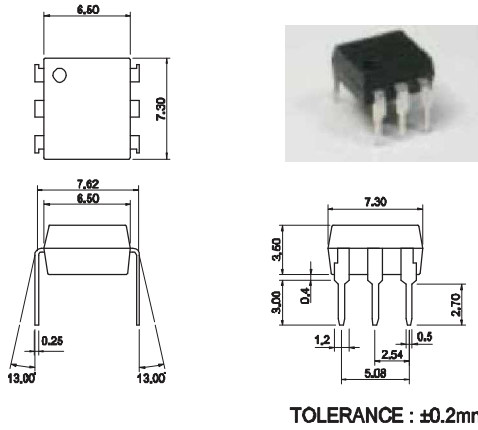

Fig.5 : 6-pin SMD type

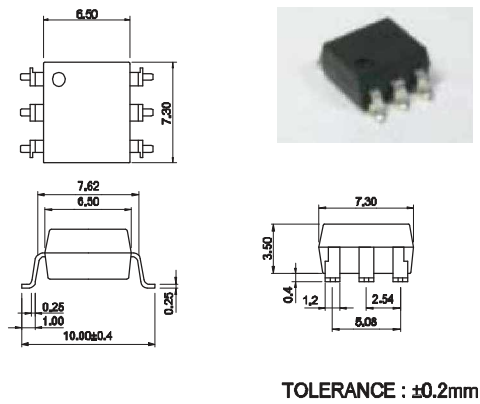

Fig.6 : 6-pin G type

